

# INSTRUCTION MANUAL

## MW105 & MW106 MAX pH / ORP / Temperature Portable Meters





**THANK YOU** for choosing Milwaukee Instruments!

**This instruction manual will provide you the necessary information for correct use of the meters.**

*All rights are reserved. Reproduction in whole or in part is prohibited without the written consent of the copyright owner, Milwaukee Instruments Inc., Rocky Mount, NC 27804 USA.*

## TABLE OF CONTENTS

1. PRELIMINARY EXAMINATION .....	4
2. INSTRUMENT OVERVIEW .....	5
3. SPECIFICATIONS .....	6
4. FUNCTIONAL & DISPLAY DESCRIPTION.....	8
5. MA906BR/1 pH & Temperature Probe.....	13
6. GENERAL OPERATIONS.....	14
6.1. BATTERY MANAGEMENT & REPLACEMENT.....	14
6.2. CONNECTING THE PROBE.....	14
6.3. ELECTRODE CARE & MAINTENANCE.....	15
7. SETUP .....	17
7.1. SETUP OPTIONS.....	17
8. pH .....	23
8.1. PREPARATION .....	23
8.2. CALIBRATION .....	23
8.3. MEASUREMENT.....	26
8.4. WARNINGS & MESSAGES.....	27
9. ORP .....	31
9.1. PREPARATION .....	31
9.2. MEASUREMENT.....	31
10. LOGGING (MW106) .....	32
10.1. TYPES OF LOGGING .....	32
10.2. DATA MANAGEMENT .....	35
11. MEM & MR FUNCTIONS (MW105).....	42
12. GLP .....	43
13. TROUBLESHOOTING.....	44
14. ACCESSORIES.....	45
CERTIFICATION.....	46
RECOMMENDATION .....	46
WARRANTY.....	46

## 1. PRELIMINARY EXAMINATION

Each **MW105** & **MW106** portable meter is delivered in a rugged carrying case and is supplied with:

- **MA906BR/1** amplified pH/temperature probe
- **M10004** pH 4.01 buffer solution (20 mL sachet)
- **M10007** pH 7.01 buffer solution (20 mL sachet)
- **M10010** pH 10.01 buffer solution (20 mL sachet)
- **M10016** electrode cleaning solution (20 mL sachet)
- 1.5V alkaline AA battery (3 pcs.)
- Micro USB cable (**MW106**)
- Instrument quality certificate
- Instruction manual

## 2. INSTRUMENT OVERVIEW

**MW105** and **MW106** meters combine the main features of a benchtop unit into a portable, IP67 rated meter.

The meters perform accurate measurements and present a series of new diagnostic features for improved reliability.

- Easy to read LCD display
- Auto-off feature to prolong battery life
- Internal clock and date to keep track of time-dependent functions (calibration timestamp, calibration time out)
- Up to 3-point (5-point, **MW106**) automatic pH calibration, using 7 standard buffers (pH 1.68, 4.01, 6.86, 7.01, 9.18, 10.01 and 12.45) and 2 custom buffers (**MW106**)
- Available log space for up to 1000 records (**MW106**)
- Logged data can be exported using a USB cable
- Dedicated GLP key to store and recall data on system status

**Note:** For direct ORP measurements, with mV readings in the  $\pm 2000$  mV range, users can replace the MA906BR/1 pH/temperature probe for an ORP probe.

**3. SPECIFICATIONS**

	<b>MW105</b>	<b>MW106</b>
Range *	pH	-2.00 to 20.00 pH
	mV	±2000.0 mV
	Temp.	-20.0 to 120.0 °C (-4.0 to 248.0 °F)
Resolution	pH	0.01 pH
	mV	0.1 mV
	Temp.	0.1 °C (0.1 °F)
Accuracy * @ 25 °C (77 °F)	pH	±0.02 pH
	mV	±1 mV
Temperature accuracy *	±0.5 °C for -5.0 to 60.0 °C (±1 °C outside) ±1 °F for 23.0 to 140.0 °F (±2 °F outside)	
pH calibration	Automatic, 7 standard buffers (1.68, 4.01, 6.86, 7.01, 9.18, 10.01, 12.45)	
	up to 3-point	up to 5-point
	—	2 custom buffers
ORP calibration	Factory calibrated	
Temperature compensation *	ATC – automatic MTC – manual, without temperature probe -20.0 to 120.0 °C (-4.0 to 248.0 °F)	
Memory	Memory & Recall function	Max. 1000 log records (stored in up to 100 lots) On demand, 200 logs On stability, 200 logs Interval logging, 1000 logs
PC connectivity	—	1 micro USB port
Battery type	3 x 1.5V alkaline AA	
Battery life	Approx. 200 hours	
Environment	0 to 50°C (32 to 122 °F); maximum RH 95%	
Dimensions	200 x 85 x 50 mm; (7.9 x 3.3 x 2.0")	
Casing	IP67 protection level	
Weight	260 g (0.57 lb)	

\* Limits will be reduced to actual sensor limits.

**PROBE SPECIFICATIONS**

		<u>Amplified pH/temperature</u>
pH probe <b>MA906BR/1</b>	Temperature range	-5 to 70 °C (23 to 123 °F)
	pH range	0 to 12 pH
	pH accuracy	±0.02 pH
	Cable length	1 m (3.2 ft)

## 4. FUNCTIONAL & DISPLAY DESCRIPTION

### MW105 Front Panel

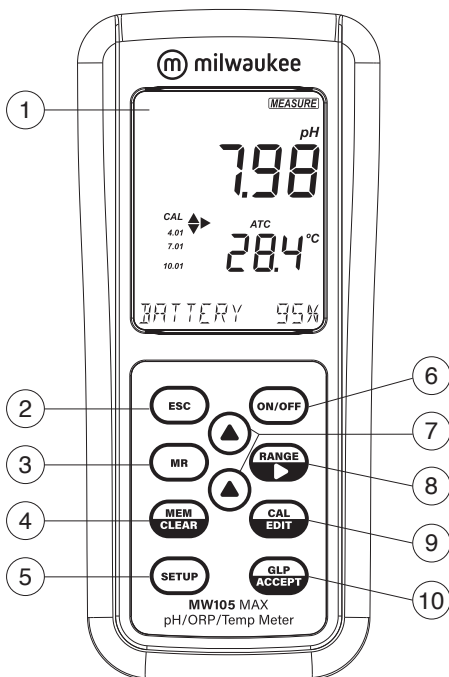

1. Liquid Crystal Display (LCD)
2. ESC key, to exit current mode
3. MR key, to recall the stored value
4. MEM/CLEAR key, to store the reading or to clear calibration or memory
5. SETUP key, to enter Setup mode
6. ON/OFF key
7. ▲▼ directional keys (menu navigation, setting parameters)
8. RANGE/▶ key, to select pH or mV
9. CAL/EDIT key, to enter / edit calibration settings, setup settings
10. GLP/ACCEPT key, to enter GLP or to confirm selected action

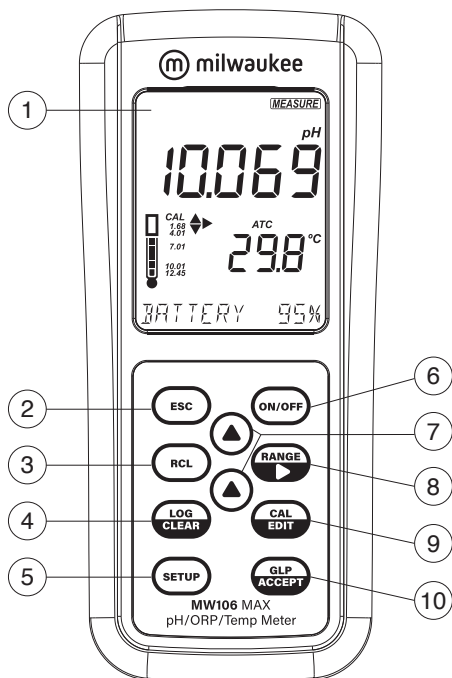

**MW106 Front Panel**

1. Liquid Crystal Display (LCD)
2. ESC key, to exit current mode
3. RCL key, to recall logged values
4. LOG/CLEAR key, to log the reading or to clear calibration or logging
5. SETUP key, to enter Setup mode
6. ON/OFF key
7. ▲▼ directional keys (menu navigation, setting parameters)
8. RANGE/▶ key, to select pH or mV
9. CAL/EDIT key, to enter / edit calibration settings, setup settings
10. GLP/ACCEPT key, to enter GLP or to confirm selected action

### MW105 Top Panel

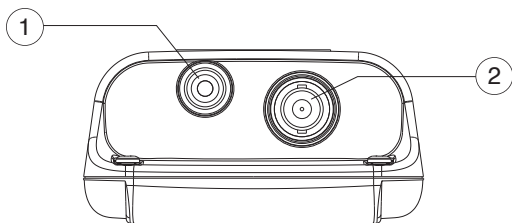

1. RCA probe socket
2. BNC probe socket

### MW106 Top Panel

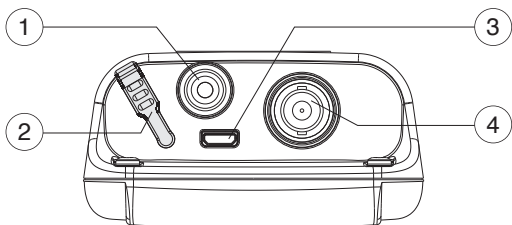

1. RCA probe socket
2. Micro USB port cap
3. Micro USB port
4. BNC probe socket

## MW105 Display Description

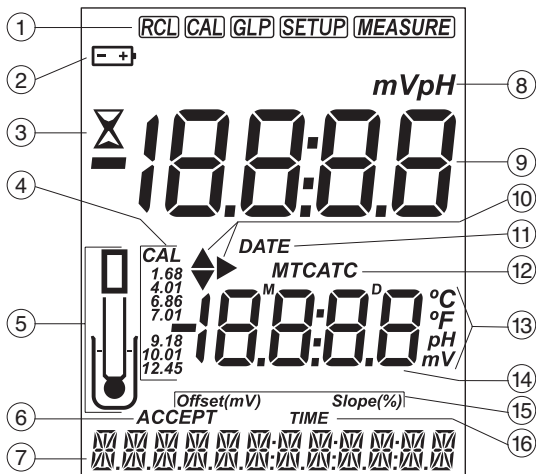

1. Mode tags
2. Battery status
3. Stability indicator
4. CAL tag and pH calibration buffers
5. Probe symbol
6. ACCEPT tag
7. Third LCD line, message area
8. Measurement units
9. First LCD line, measurement readings
10. Arrow tags, to navigate the menu in either direction
11. DATE tag
12. Temperature compensation status (MTC, ATC)
13. Temperature and measurement units
14. Second LCD line, temperature readings
15. Offset / Slope indicators
16. TIME tag

## MW106 Display Description

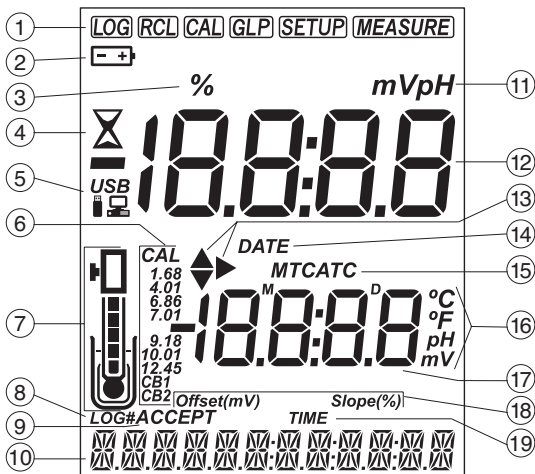

1. Mode tags
2. Battery status
3. Percentage tag
4. Stability indicator
5. USB / PC connection status
6. CAL tag and pH calibration buffers
7. Probe symbol and probe condition
8. LOG tag
9. ACCEPT tag
10. Third LCD line, message area
11. Measurement units
12. First LCD line, measurement readings
13. Arrow tags, to navigate the menu in either direction
14. DATE tag
15. Temperature compensation status (MTC, ATC)
16. Temperature and measurement units
17. Second LCD line, temperature readings
18. Offset / Slope indicators
19. TIME tag

## 5. MA906BR/1 pH & Temperature Probe

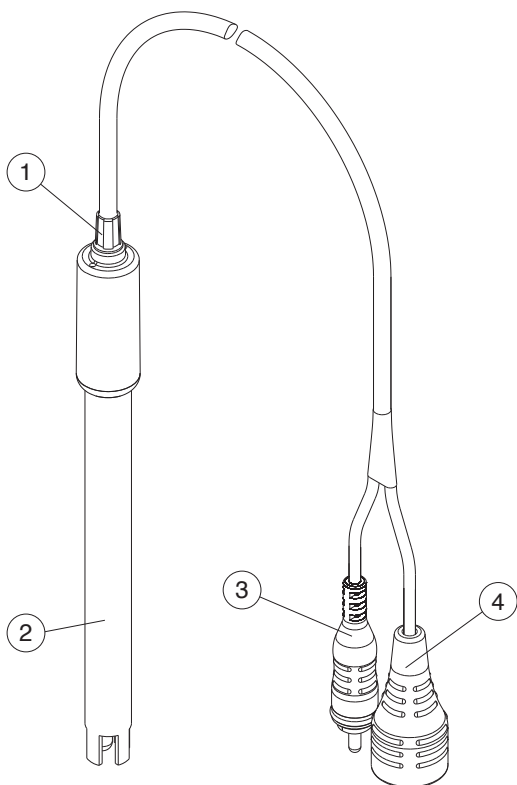

1. Strain relief
2. Probe body
3. RCA probe connector
4. BNC probe connector

## 6. GENERAL OPERATIONS

### 6.1. BATTERY MANAGEMENT & REPLACEMENT

The meters are supplied with 3 x 1.5V alkaline AA batteries and equipped with Battery Error Prevention System (BEPS) feature, which turns the meter off after 10 minutes of non-use (see SETUP OPTIONS, Auto Off section).

At power on, the instruments perform an auto-diagnostic test and all LCD segments are displayed for a few seconds.

Use ▲▼ keys to check the battery percentage.

#### To replace the batteries

1. Turn the meter off.
2. Remove the 4 screws on the back of the meter to open the battery compartment.
3. Remove the old batteries.
4. Insert the three new 1.5V AA batteries while paying attention to their polarity.
5. Close the battery compartment using the 4 screws.

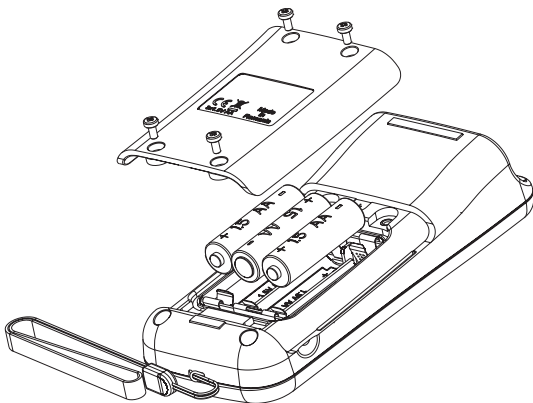

### 6.2. CONNECTING THE PROBE

With the meter off, connect the **MW906BR/1** probe's connectors to the BNC and RCA sockets on the top of the meter.

**Note:** When the temperature sensor is not connected, temperature can be set manually by pressing CAL/EDIT then using ▲▼ keys. See SETUP OPTIONS, MTC Mode section.

## 6.3. ELECTRODE CARE & MAINTENANCE

### Calibrating & Conditioning

Maintaining a pH electrode is critical to ensure proper and reliable measurements.

Frequent 2- or 3-point calibrations are recommended to ensure accurate and repeatable results.

### Prior to using the electrode for the first time

1. Remove the protective cap. Do not be alarmed if salts deposits are present, this is normal. Rinse the electrode with distilled or deionized water.
2. Place the electrode in a beaker containing **MA9016** Cleaning solution for a minimum of 30 minutes.

***Note:** Do not condition a pH electrode in distilled or deionized water as this will damage the glass membrane.*

3. After conditioning, rinse the sensor with distilled or deionized water.

***Note:** To ensure quick response and avoid cross-contamination, rinse the electrode tip with the solution to be tested before measurement.*

### Best practice when handling an electrode

- Electrodes should always be rinsed between samples with distilled or deionized water.
- Do not wipe an electrode as wiping can cause erroneous readings due to static charges.
- Blot the end of the electrode with lint-free paper.

### Storage

To minimize clogging and ensure quick response time, the glass bulb and the junction should be kept hydrated.

Add a few drops of **MA9015** Storage solution to the protective cap. Replace the storage cap when the probe is not in use.

***Note:** Never store the probe in distilled or deionized water.*

## Regular Maintenance

- Inspect the probe. If cracked, replace the probe.
- Inspect the cable. Cable and insulation must be intact.
- Connectors should be clean and dry.
- Rinse off salt deposits with water.
- Follow storage recommendations.

If electrodes are not maintained correctly both accuracy and precision are affected. This can be observed as a steady decrease in the slope of the electrode.

The slope (%) indicates the sensitivity of the glass membrane, the offset value (mV) indicates the age of electrode and provides an estimation when the probe needs to be changed. The slope percentage is referenced to the ideal slope value at 25 °C.

Milwaukee Instruments recommends that the offset does not exceed  $\pm 30$  mV and that the slope percentage is between 85-105%. When the slope value drops below 50 mV per decade (85% slope efficiency) or the offset at the zero point exceeds  $\pm 30$  mV, reconditioning may improve performance, but a change of electrode may be necessary to ensure accurate pH measurements.

## Electrode Status (MW106)

**MW106** displays electrode status after calibration. See probe icon on the LCD screen. The assessment remains active for 12 hours and is based on the electrode offset and slope during calibration.

	5 bars	Excellent condition
	4 bars	Very good condition
	3 bars	Good condition
	2 bars	Fair condition
	1 bar	Poor condition
	1 bar blinking	Very poor condition
	no bar	Not calibrated

Recommendations:

- **1 bar:** Clean the electrode and recalibrate. If there is still only 1 bar or 1 bar blinking after recalibration, replace the probe.
- **No bar:** Instrument was not calibrated on current day or a one-point calibration was performed with previous calibration not yet deleted.



## 7. SETUP

To configure the meter settings, modify default values or set measurement parameters:

- Press SETUP to enter (or exit) Setup mode
- Use ▲▼ keys to navigate the menus (view parameters)
- Press CAL/EDIT to enter Edit mode (modify parameters)
- Press RANGE/▶ key to select between options  
Use ▲▼ keys to modify values (value being modified is displayed blinking)
- Press GLP/ACCEPT to confirm and save changes (ACCEPT tag is displayed blinking)
- Press ESC (or CAL/EDIT again) to exit Edit mode without saving (return to menu)

### 7.1. SETUP OPTIONS

#### Log Type (MW106)

Options: INTERVAL (default), MANUAL or STABILITY

Press RANGE/▶ to select between options.

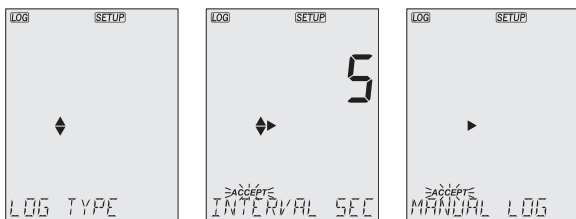

Use ▲▼ keys to set time interval: 5 (default), 10, 30 sec. or 1, 2, 5, 15, 30, 60, 120, 180 min.

Use ▲▼ keys to select stability type: fast (default), medium or accurate.

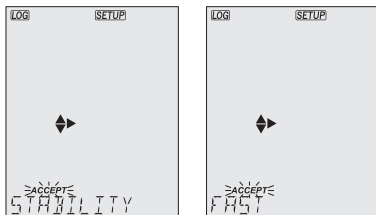

### Calibration Expired Warning

Options: 1 to 7 days (default) or off

Use ▲▼ keys to select the number of days since last calibration has elapsed.

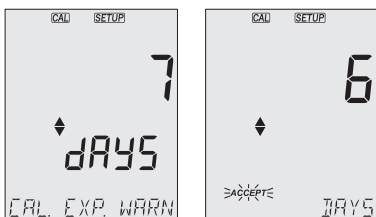

### pH Information

Options: On (default) or Off (disabled)

Use ▲▼ keys to select.

Displays pH buffer calibration information. When enabled, the electrode symbol displays the electrode condition (**MW106**).

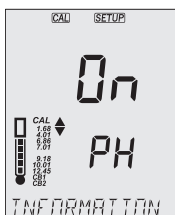

### First Custom Buffer (MW106)

Press RANGE/▶ to set a default buffer value as starting value.

Use ▲▼ keys to set the value of the first custom buffer.

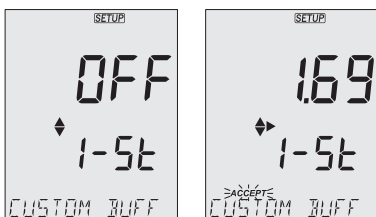

### Second Custom Buffer (MW106)

Press RANGE/▶ to set a default buffer value as starting value.

Use ▲▼ keys to set the value of the second custom buffer.

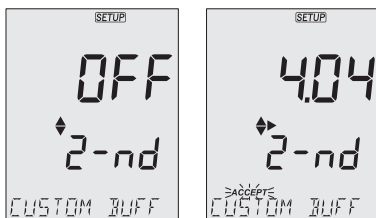

### pH Resolution (MW106)

Options: 0.01 (default) and 0.001

Use ▲▼ keys to select.

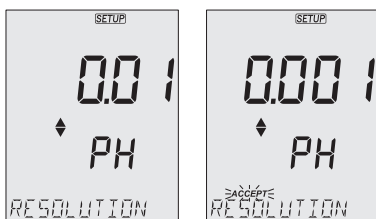

### Out of Calibration Range Warning

Options: On (default) or Off (disabled)

Use ▲▼ keys to select.

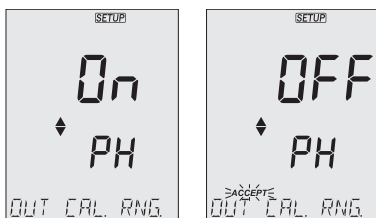

### Date

Options: year, month or day

Press RANGE/▶ to select. Use ▲▼ keys to modify the values.

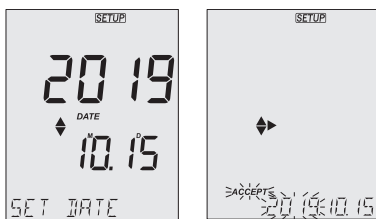

## Time

Options: hour, minute or second

Press RANGE/▶ to select. Use ▲▼ keys to modify the values.

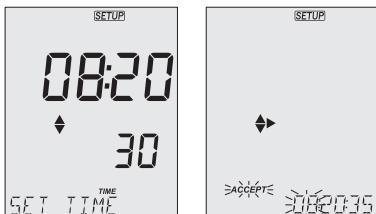

## Auto Off

Options: 5, 10 (default), 30, 60 minutes or off

Use ▲▼ keys to select the time.

The meter will power off after set period of time.

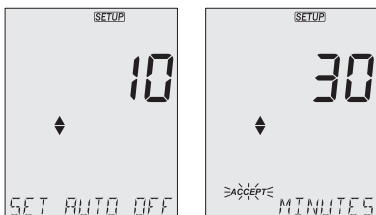

## Sound

Options: enable (default) or disable

Use ▲▼ keys to select.

When pressed, each key will emit a short acoustic signal.

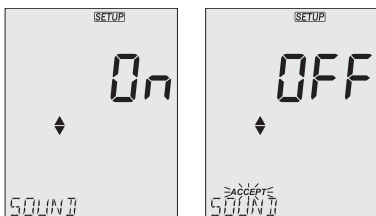

## Temperature Unit

Options: °C (default) or °F.

Use ▲▼ keys to select the unit.

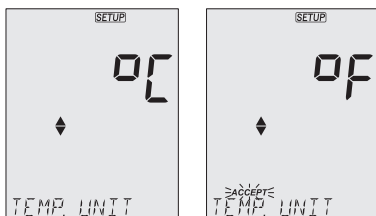

### LCD Contrast

Options: 1 to 9 (default)

Use ▲▼ keys to set LCD contrast values.

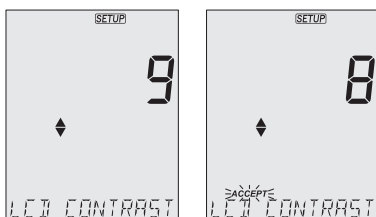

### Default Values

Resets meter settings to factory defaults.

Press GLP/ACCEPT to restore the default values. "RESET DONE" message confirms that the meter performs with default settings.

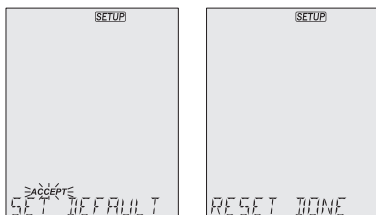

### Instrument Firmware Version

Displays the installed firmware version.



### Meter ID / Serial Number

Use ▲▼ keys to assign a meter ID from 0000 to 9999.  
Press RANGE/▶ to view the serial number.

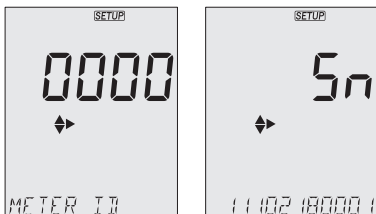

### Separator Type (MW106)

Option: comma (default) or semicolon. Use ▲▼ keys to select.  
Change the columns separator type for the CSV file.

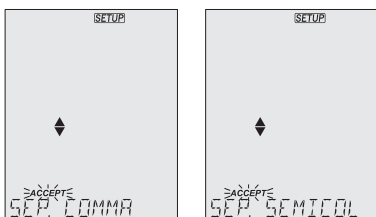

### Export to PC / Log on Meter (MW106)

Options: Export to PC and Log on Meter

With the micro USB cable connected, press SETUP. Press CAL/EDIT to enter Edit mode. Use ▲▼ keys to select.

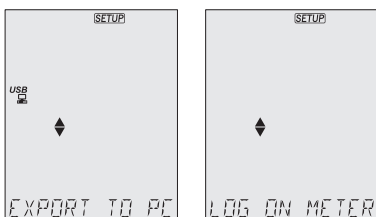

**Note:** This option is only available while connected to a PC. The USB/PC icon is not displayed if LOG ON METER option was previously set.

## 8. pH

### 8.1. PREPARATION

**MW105:** Up to 3-point calibration using 7 standard buffers.

**MW106:** Up to 5-point calibration using 7 standard buffers and 2 custom buffers (CB1 and CB2).

1. Prepare two clean beakers. One beaker is for rinsing and one for calibration.
2. Pour small quantities of the selected buffer solution into each beaker.
3. Remove the protective cap and rinse the probe with the buffer solution for the first calibration point.

### 8.2. CALIBRATION

#### General Guidelines

For better accuracy, frequent calibrations are recommended.

The probe should be recalibrated at least once a week, or:

- Whenever is replaced
- After testing aggressive samples
- When high accuracy is required
- When the calibration time out has expired

#### Procedure

1. Place the pH probe tip approximately 4 cm (1½") into the buffer solution and stir gently. For a 2-point calibration, use the pH 7.01 (pH 6.86 for NIST) buffer first. Press CAL/EDIT to enter Calibration mode. Buffer value and "WAIT" message are displayed blinking. If required, use the ▲ ▼ keys to select a different buffer value.

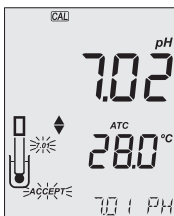

2. When the reading is stable and close to the selected buffer, the ACCEPT tag is displayed blinking. Press GLP/ACCEPT to confirm calibration.

3. After the first calibration point has been confirmed, the calibrated value is displayed on the first LCD line and the second expected buffer value on the third LCD line (i.e. pH 4.01). The value of the first buffer is set while the second expected buffer value is displayed blinking on the screen.

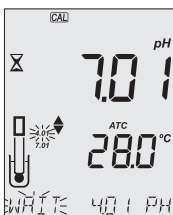

For one-point calibration, press CAL/EDIT to exit calibration. The meter stores the calibration and returns to Measurement mode.

To continue calibrating with additional buffers, rinse and place the pH probe tip approximately 4 cm (1½") into the second buffer solution and stir gently.

If needed, use the ▲▼ keys to select a different buffer value.

**Note:** When attempting to calibrate with a different buffer (not yet used), the previously used buffers are displayed blinking.

Follow the same steps for 2- or 3-point calibration.

Press CAL/EDIT to exit calibration. The meter stores the calibration and returns to Measurement mode.

For improved accuracy, a minimum of 2-point calibration is recommended.

**Note:** When performing a new calibration (or adding to an existing calibration) the first calibration point is treated as an offset. Press CAL/EDIT after the first or second calibration point has been confirmed, and the instrument stores the calibration data and returns to Measurement mode.

### 5-Point Calibration (MW106)

The 3-point calibration procedure can be continued up to 5-point following the same steps.



### Custom Buffers (MW106)

This feature has to be enabled in Setup. Temperature compensation of custom buffers is set to the value of 25°C.

Calibrating with custom buffers:

- Press RANGE/▶. The custom buffer value is blinking on the third LCD line.
- Use the ▲▼ keys to modify the value based on the temperature reading. The buffer value is updated after 5 sec.

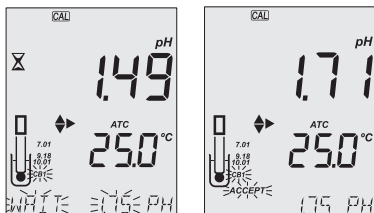

**Note:** When using custom buffers, CB1 and CB2 tags are displayed. If only one custom buffer is used, CB1 is displayed together with its value.

### Expired Calibration

The instrument has a real time clock (RTC) to monitor the time elapsed since the last pH calibration.

The RTC is reset every time the instrument is calibrated and the “expired calibration” status is triggered when the meter detects calibration time out. The “CAL EXPIRED” warns the user that the instrument should be recalibrated.

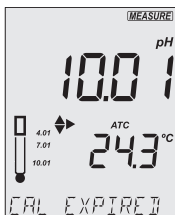

If the instrument is not calibrated or calibration has been deleted, the “NO CAL” message is displayed.

Calibration time-out function can be set from 1 to 7 days (default) or off. See Setup section Calibration Expired Warning for details.

For example, if the warning has been set to 4 days, the instrument will issue the alarm 4 days after the last calibration.

## Clear Calibration

1. Press CAL/EDIT to enter Calibration mode.
2. Press LOG/CLEAR (MEM/CLEAR).  
ACCEPT tag is displayed blinking and "CLEAR CAL" message is displayed on the third LCD line.
3. Press GLP/ACCEPT to confirm.  
"PLEASE WAIT" message is displayed followed by the "NO CAL" confirmation screen.

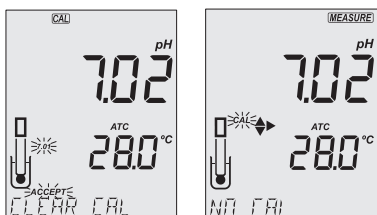

## 8.3. MEASUREMENT

Remove the probe protective cap and place the tip approximately 4 cm (1 ½") into the sample. It is recommended to wait for the sample and the pH probe to reach the same temperature.

If necessary, press the RANGE/▶ until the display changes to the pH mode. Allow the reading to stabilize (∞ stability tag to turn off).

The LCD will display:

- Measurement and temperature readings
- Temperature compensation mode (MTC or ATC)
- Buffers used (if option enabled in Setup)
- **MW106:** Electrode condition (if option enabled in Setup)
- The third LCD line displays: mV offset & slope values, time and date of measurement, battery status. Use the ▲▼ keys to scroll between them.

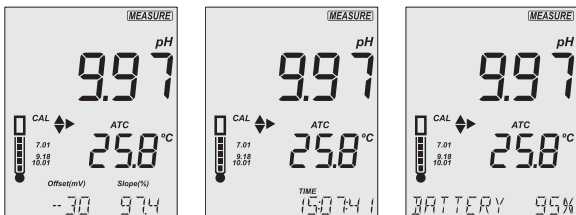

For best results is recommended to:

- Calibrate the probe before use and recalibrate periodically
- Keep the electrode hydrated
- Rinse the probe with the sample before use
- Soak in **MA9015** Storage solution for at least 1 hour before measurement

### MTC Mode

When the probe is not connected the “NO T. PROBE” message is displayed. The MTC tag and the default temperature (25 °C) with blinking temperature unit are displayed.

1. Press CAL/EDIT and use the ▲▼ keys to set the temperature value manually.
2. Press GLP/ACCEPT to confirm or press ESC (or CAL/EDIT again) to exit without saving.

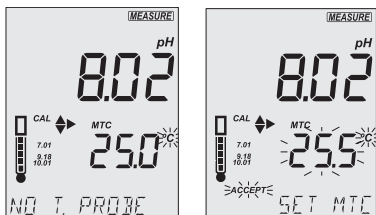

**Note:** The temperature value used for MTC can be set only when “NO T. PROBE” message is displayed.

## 8.4. WARNINGS & MESSAGES

### Messages displayed during calibration

- “WRONG BUFFER” message is displayed blinking when the difference between the pH reading and selected buffer value is significant. Check if correct calibration buffer has been used.



- “WRONG OLD POINTS INCONSISTENT” is displayed if there is discrepancy between new calibration value and old value recorded when calibrating with the same probe in a buffer of the same value. Clear the previous calibration and calibrate with fresh buffers. See Clear Calibration section for details.

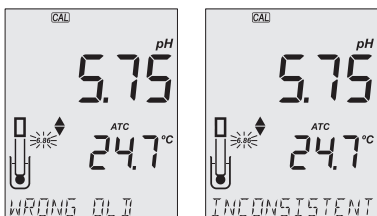

- “CLEAN ELEC” indicates poor electrode performance (the offset is out of the accepted window, or the slope is under the accepted lower limit). Clean the probe to improve response time. See pH Electrode Conditioning and Maintenance for details. Repeat calibration after cleaning.

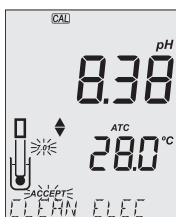

- “CHECK PROBE CHECK BUFFER” is displayed when the electrode's slope exceeds the highest accepted slope limit. Inspect the electrode and make sure the buffer solution is fresh. Clean the probe to improve response time.

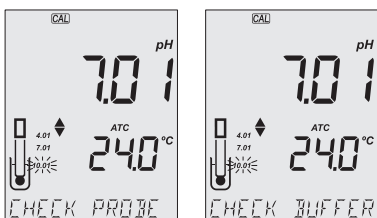

- “BAD ELEC” is displayed when after cleaning, the electrode's performance has not improved. Replace the probe.



- “WRONG TEMP” is displayed when buffer temperature is out of range. The calibration buffers are affected by temperature changes. During calibration, the instrument will automatically calibrate to the pH value corresponding to the measured temperature but compensate it to the value of 25 °C.

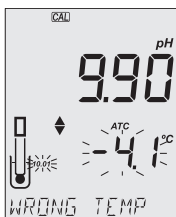

- When “CONTAMINATED BUFFER” is displayed, replace the buffer with a new one and continue the calibration.

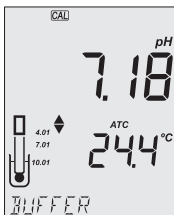
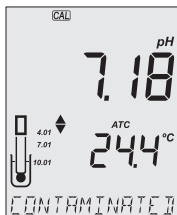

- **MW106** “VALUE USED BY CUST 1” or “VALUE USED BY CUST 2” message is displayed when attempting to set a custom buffer of the same value as the one previously set. Make sure that set custom buffers have different values.

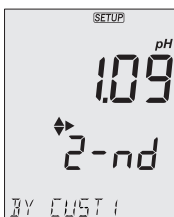
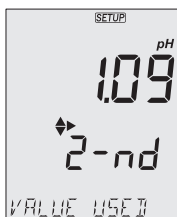

- "OUT CAL RNG" is displayed when the measured value is outside calibration range. The option has to be enabled (see SETUP OPTIONS, Out of Calibration Range Warning section).

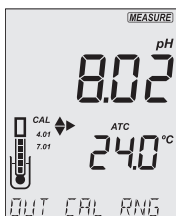

- "OUT OF SPEC" message and the temperature value (blinking) are displayed when the measured temperature is out of range.

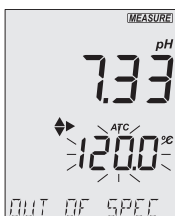

- Closest boundary value is displayed blinking when the reading is out of range.



## 9. ORP

### 9.1. PREPARATION

The instrument measures the ORP generated by the pH electrode while in mV mode.

For accurate ORP measurements, the surface of the electrode must be clean and smooth. Pretreatment solutions are available to condition the electrode and improve its response time (see ACCESSORIES section).

The ORP range is factory calibrated.

**Note:** For direct ORP measurements, use an ORP probe. MA9020 ORP Solution can be used to confirm that the ORP sensor measures correctly. mV readings are not temperature compensated.

### 9.2. MEASUREMENT

1. Press the RANGE/▶ until the display changes to mV mode.
2. Remove the probe protective cap and immerse the tip approximately 4 cm (1½") into the sample. Allow the reading to stabilize (X tag turns off).

The ORP mV reading is displayed on the first LCD line.

The second LCD line displays the temperature of the sample.



## 10. LOGGING (MW106)

**MW106** supports three types of logging: manual log on demand, log on stability and interval logging. See Log Type (**MW106**) in SETUP OPTIONS.

The meter can hold up to 1000 log records. Up to 200 for manual log on demand, up to 200 for log on stability and up to 1000 for interval logging. See DATA MANAGEMENT section.

***Note:** An interval logging lot can hold up to 600 records. When an interval logging session exceeds 600 records, another log file is automatically generated.*

### 10.1. TYPES OF LOGGING

#### Manual log on demand

- Readings are logged each time LOG/CLEAR is pressed
- All manual readings are stored in a single lot (i.e. records made on different days share the same lot)

#### Log on stability

- Readings are logged each time LOG/CLEAR is pressed and stability criteria is reached
- Stability criteria can be set to fast, medium or accurate
- All stability readings are stored in a single lot (i.e. records made on different days are logged in the same lot)

#### Interval logging

- Readings are logged continuously at a set time interval (e.g. every 5 or 10 minutes).
- Records are added to it until the session stops.
- For each interval logging session, a new lot is created.

A complete set of GLP information including date, time, range selection, temperature reading and calibration information is stored with each log.



## Manual Log on Demand

1. From the Setup mode, set Log Type to MANUAL.
2. From the measurement screen press LOG/CLEAR.  
LCD displays "PLEASE WAIT". The LOG ### "SAVED" screen displays stored log number. "FREE" ### screen displays the number of available records.  
Meter then returns to measurement screen.

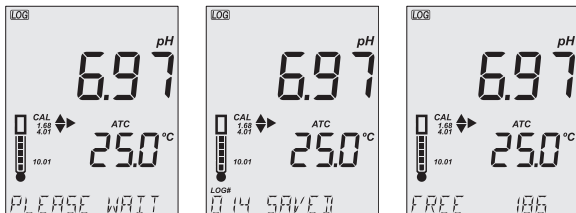

## Log on Stability

1. From the Setup mode, set Log Type to STABILITY and the desired stability criteria.
2. From the measurement screen press LOG/CLEAR.  
LCD displays "PLEASE WAIT" then "WAITING", until stability criteria is reached. The LOG ### "SAVED" screen displays stored log number. "FREE" ### screen displays total number of available records. Meter then returns to measurement screen.

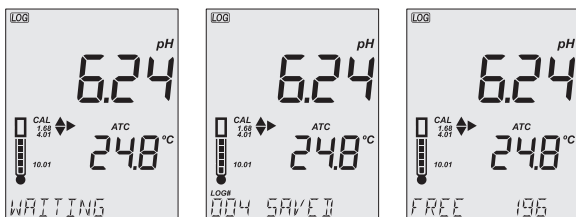

**Note:** Pressing ESC or LOG/CLEAR with "WAITING" displayed, exits without logging.

## Interval Logging

1. From the Setup mode, set Log Type to INTERVAL (default) and desired time interval.
2. From the measurement screen press LOG/CLEAR.  
LCD displays "PLEASE WAIT". The LOG ### LOT ### screen displays on third LCD line the measurement log number (bottom left) and interval logging session lot number (bottom right).

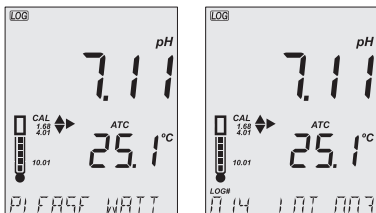

3. Press RANGE/▶ during logging to display the number of available records ("FREE" ###). Press RANGE/▶ again to return to return to active logging screen.

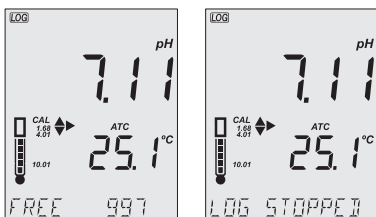

4. Press LOG/CLEAR again (or ESC) to end current interval logging session. LCD displays "LOG STOPPED". Meter returns to measurement screen.

## Interval Logging Warnings

"OUT OF SPEC"	Sensor failure is detected. Loggings stops.
"MAX LOTS"	Maximum number of lots reached (100). Cannot create new lots.
"LOG FULL"	Log space is full (1000 logs limit was reached). Loggings stops.

## 10.2. DATA MANAGEMENT

- A lot contains 1 to 600 log records (saved measurement data)
- Maximum number of lots that can be stored is 100, excluding Manual and Stability
- Maximum number of log records that can be stored is 1000, across all lots
- Manual and Stability logs can store up to 200 records (each)
- Interval logging sessions (across all 100 lots) can store up to 1000 records. When a logging session exceeds 600 records a new lot will be created.
- Lot name is given by a number, from 001 up to 999. Names are allocated incrementally, even after some lots have been deleted. Once lot name 999 was assigned, all lots have to be deleted, to reset lot naming to 001.

See Deleting Data section.

### 10.2.1. Viewing Data

1. Press RCL to access the logged data.  
LCD displays "PLEASE WAIT" followed by "LOG RECALL" with ACCEPT tag blinking and the number of stored logs.

**Note:** Press RANGE/▶ to export all saved lots to external storage.

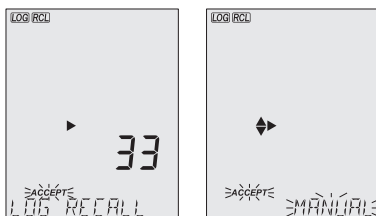

2. Press GLP/ACCEPT to confirm.
3. Use ▲▼ keys to select the lot type (MANUAL, STABILITY or interval ###).

**Note:** Press RANGE/▶ to export only the selected lot to external storage.

4. Press GLP/ACCEPT to confirm.
5. With a lot selected, use ▲▼ keys to view the records stored in that lot.
6. Press RANGE/▶ to view, additional log data: date, time, cell factor, temperature coefficient, temperature reference, displayed on the third LCD line.

## 10.2.2. Deleting Data

### Manual Log on Demand & Stability Log

1. Press RCL to access the logged data.  
LCD displays "PLEASE WAIT" followed by "LOG RECALL" with ACCEPT tag blinking and the number of stored logs.
2. Press GLP/ACCEPT to confirm.
3. Use ▲▼ keys to select MANUAL or STABILITY lot type.
4. With a lot selected, press LOG/CLEAR to delete entire lot.  
"CLEAR" is displayed with ACCEPT tag and lot name blinking.
5. Press GLP/ACCEPT to confirm (to exit, press ESC or CAL/EDIT or LOG/CLEAR). "PLEASE WAIT" with ACCEPT tag blinking is displayed, until the lot is deleted. After the selected lot has been deleted, "CLEAR DONE" displays briefly.  
Display shows "NO MANUAL / LOGS" or "NO STABILITY / LOGS".



### Individual Logs / Records

1. Press RCL to access the logged data.  
LCD displays "PLEASE WAIT" followed by "LOG RECALL" with ACCEPT tag blinking and the total number of logs.
2. Press GLP/ACCEPT to confirm.
3. Use ▲▼ keys to select MANUAL or STABILITY lot type.
4. Press GLP/ACCEPT to confirm.
5. Use the ▲▼ to navigate between logs. Log record number displays on the left.
6. With desired log record selected, press LOG/CLEAR to delete.  
"DELETE" is displayed with ACCEPT tag and log ### blinking.
7. Press GLP/ACCEPT to confirm (to exit, press ESC or CAL/EDIT or LOG/CLEAR). "DELETE" and Log ### blinking is displayed, until the log is deleted. After the log has been deleted "CLEAR DONE" message displays briefly. Display shows logged data of the next log ###.

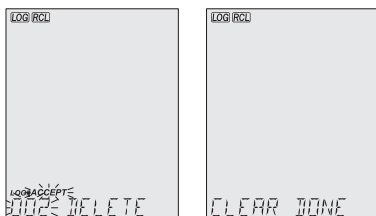

**Note:** Logs stored within an interval lot can not be deleted individually.

### Log on Interval

1. Press RCL to access the logged data.  
LCD displays "PLEASE WAIT" followed by "LOG RECALL" with ACCEPT tag blinking and the total number of logs.
2. Press GLP/ACCEPT to confirm.
3. Use ▲▼ keys to select an interval logging lot number.  
The LOG ### LOT ### screen displays selected lot number (bottom right) and total logs stored in lot (bottom left).
4. Press GLP/ACCEPT to confirm (to exit, press ESC or CAL/EDIT or LOG/CLEAR).
5. With the lot selected, press LOG/CLEAR to delete entire lot.  
"CLEAR" is displayed with ACCEPT tag and lot name blinking.

**Note:** Use ▲▼ keys to select a different lot number.

6. Press GLP/ACCEPT to confirm (to exit, press ESC or CAL/EDIT or LOG/CLEAR). "PLEASE WAIT" with ACCEPT tag blinking is displayed, until the lot is deleted. After the lot has been deleted "CLEAR DONE" message displays briefly.  
Display shows the previous lot ###.

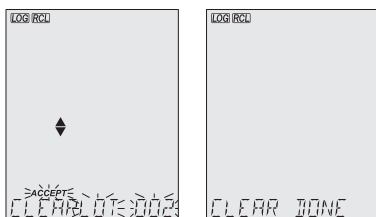

## Delete All

1. Press RCL to access the logged data.  
LCD displays "PLEASE WAIT" followed by "LOG RECALL" with ACCEPT tag blinking and the number of stored logs.
2. Press LOG/CLEAR to delete all logs.  
"CLEAR ALL" is displayed with ACCEPT tag blinking.
3. Press GLP/ACCEPT to confirm (to exit, press ESC or CAL/EDIT; or LOG/CLEAR). "PLEASE WAIT" is displayed with a percentage counter, until all logs are deleted. After all logs have been deleted "CLEAR DONE" message displays briefly.  
Display returns to the log recall screen.

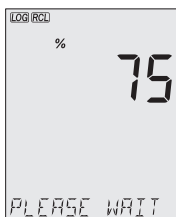
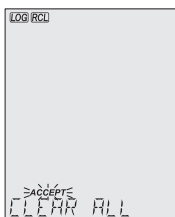

## 10.2.3. Exporting Data

### PC Export

1. With the meter on, use the supplied micro USB cable to connect to a PC.
2. Press SETUP then CAL/EDIT.
3. Use the ▲▼ keys and select "EXPORT TO PC".  
The meter is detected as a removable drive. LCD displays the PC icon.
4. Use a file manager to view or copy files on the meter.

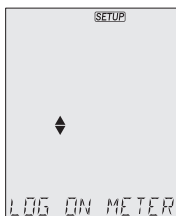
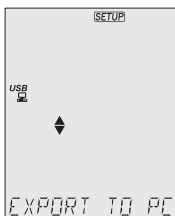

When connected to a PC, to enable logging:

- Press LOG/CLEAR. LCD displays “LOG ON METER” with ACCEPT tag blinking.
- Press GLP/ACCEPT. Meter disconnects from the PC and the PC icon is no longer displayed.
- To return to “EXPORT TO PC” mode, follow steps 2 and 3 above.

Exported data file details:

- The CSV file (comma separated values) may be opened with a text editor or spreadsheet application.
- The CSV file encoding is Western Europe (ISO-8859-1).
- Field separator may be set as comma or semicolon. See Separator Type (**MW106**) in SETUP OPTIONS section.
- Interval log files are named PHLOT###, where ### is the lot number (e.g. PHLOT051).
- Manual log file is named PHLOTMAN and stability log file is named PHLOTSTA.

### USB Export All

1. With the meter on, insert a USB flash drive into the micro USB port located on top of the meter. If the flash drive does not have a micro USB connector, use an adapter.
2. Press RCL then RANGE/▶ to select the “EXPORT ALL” option.
3. Press GLP/ACCEPT to confirm.

LCD displays “EXPORTING” and the percentage counter, followed by “DONE” when export is completed. Display returns to the lot selection screen.

**Note:** The USB flash drive can be safely removed if the USB icon is not displayed. Do not remove the USB drive during export.

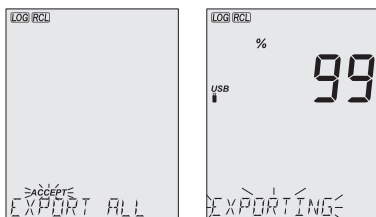

Overwriting existing data:

1. When the LCD displays "OVR" with LOT### blinking (USB icon is displayed), an identical named lot exists on the USB.
2. Press ▲ ▼ keys to select between YES, NO, YES ALL, NO ALL (ACCEPT tag blinking).
3. Press GLP/ACCEPT to confirm. Not confirming exits the export. Display returns to lot selection screen.

### USB Export Selected

Logged data can be transferred separately by lots.

1. Press RCL to access the logged data.  
LCD displays "PLEASE WAIT" followed by "LOG RECALL" with ACCEPT tag blinking and the number of stored logs.
2. Press GLP/ACCEPT to confirm.
3. Use ▲ ▼ keys to select the lot type (MANUAL, STABILITY or interval ###)
4. With the lot selected, press RANGE/▶ to export to USB flash drive.  
LCD displays "PLEASE WAIT" followed by "EXPORTING" with ACCEPT tag and selected lot name (MAN / STAB / ###) blinking. LCD displays "EXPORTING" and the percentage counter, followed by "DONE" when export is completed. Display returns to the lot selection screen.

**Note:** The USB flash drive can be safely removed if the USB icon is not displayed. Do not remove the USB drive during export.

Overwriting existing data:

1. When the LCD displays "EXPORT" with ACCEPT and lot number blinking (USB icon displayed), an identical named lot exists on the USB.
2. Press GLP/ACCEPT to continue. LCD displays "OVERWRITE" with ACCEPT tag blinking.
3. Press GLP/ACCEPT (again) to confirm. Not confirming exits the export. Display returns to lot selection screen.



### Data Management Warnings

"NO MANUAL / LOGS"	No manual records saved. Nothing to display.
"NO STABILITY / LOGS"	No stability records saved. Nothing to display.
"OVR" with lot ### (blinking)	Identically named lots on USB. Select overwrite option.
"NO MEMSTICK"	USB drive is not detected. Data can not be transferred. Insert or check the USB flash drive.
"BATTERY LOW" (blinking)	When low battery, export is not executed. Recharge the battery.

### Logged Data Warnings in CSV file

°C !	Probe used beyond its operation specifications. Data not reliable.
°C !!	Meter in MTC mode.

## 11. MEM & MR FUNCTIONS (MW105)

1. Press MEM/CLEAR when in Measurement mode.  
"MEMORY" message is displayed while the measured pH value (as well as ORP mV and temperature values) and the current calibration are saved.

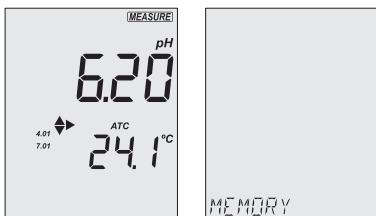

2. Press MR to recall the last recorded pH, ORP, temperature and calibration values.
3. Press RANGE/▶ to switch between pH and ORP mV values.  
With pH selected, use ▲▼ keys to switch between calibration offset/slope, date and time. With mV selected, use ▲▼ keys to switch between date and time.

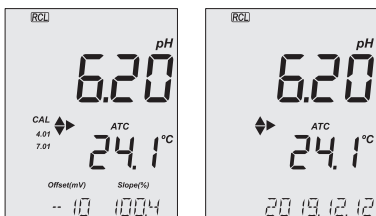

4. When MEM/CLEAR is pressed again, "CLEARING" message is displayed briefly and the saved value is deleted.  
The instrument returns to Measurement mode.  
If MR is pressed when no measured value was memorized or the memory was cleared, "NO RECORD" message is displayed.

## 12. GLP

Good Laboratory Practice (GLP) allows the user to store and recall calibration data. Correlating readings with specific calibrations ensures uniformity and consistency.

GLP information is included with every data log. pH calibration data is stored automatically after a successful calibration.

To view the pH calibration data:

- Press GLP/ACCEPT when in Measurement mode.
- Use the ▲▼ keys to scroll through the calibration data displayed on the third LCD line: Offset, slope, pH calibration solutions, Time, date, calibration expiration time.
- Press ESC or GLP/ACCEPT to return Measurement mode.

If calibration expiration time is disabled, “EXP WARN DIS” is displayed.



If the instrument has not been calibrated or calibration has been deleted, the blinking “NO CAL” message is displayed in GLP.

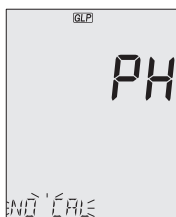



### 13. TROUBLESHOOTING

Symptoms	Problem	Solution
Slow response/ excessive drift	Dirty pH electrode	Soak the electrode tip in <b>MA9016</b> for 30 minutes, then follow the Cleaning procedure.
Display shows blinking full scale value	Reading out of range	Check if the sample is within measurable range; check general electrode status.
mV scale out of range	Dry membrane or dry junction	Soak electrode in <b>MA9015</b> storage solution for at least 30 minutes.
Display shows blinking °C or °F	Disconnected temperature sensor	Reconnect temperature sensor or replace the electrode.
Meter fails to calibrate or gives faulty readings	Broken probe	Replace the probe.
LCD tags displayed continuously at startup	ON/OFF key is blocked	Check the keyboard. If error persists, contact Milwaukee Technical Service.
"Internal Er X"	Internal hardware error	Restart the meter. If error persists, contact Milwaukee Technical Service.

## 14. ACCESSORIES

<b>MA906BR/1</b>	Combination amplified pH/temperature probe with BNC & RCA connectors and 1 m cable
<b>MA924B/1</b>	Refillable glass ORP probe with BNC connector and 1 meter cable
<b>MA9001</b>	pH 1.68 buffer solution (230 mL)
<b>MA9004</b>	pH 4.01 buffer solution (230 mL)
<b>MA9006</b>	pH 6.86 buffer solution (230 mL)
<b>MA9007</b>	pH 7.01 buffer solution (230 mL)
<b>MA9009</b>	pH 9.18 buffer solution (230 mL)
<b>MA9010</b>	pH 10.01 buffer solution (230 mL)
<b>MA9112</b>	pH 12.45 buffer solution (230 mL)
<b>MA9015</b>	Electrode storage solution (230 mL)
<b>MA9016</b>	Electrode cleaning solution (230 mL)
<b>MA9020</b>	200–275 mV ORP solution (230 mL)
<b>M10000B</b>	Electrode rinse solution (20 mL sachet, 25 pcs.)
<b>M10001B</b>	pH 1.68 buffer solution (20 mL sachet, 25 pcs.)
<b>M10004B</b>	pH 4.01 buffer solution (20 mL sachet, 25 pcs.)
<b>M10006B</b>	pH 6.86 buffer solution (20 mL sachet, 25 pcs.)
<b>M10007B</b>	pH 7.01 buffer solution (20 mL sachet, 25 pcs.)
<b>M10009B</b>	pH 9.18 buffer solution (20 mL sachet, 25 pcs.)
<b>M10010B</b>	pH 10.01 buffer solution (20 mL sachet, 25 pcs.)

## CERTIFICATION

Milwaukee Instruments conform to the CE European Directives.



**Disposal of Electrical & Electronic Equipment.** Do not treat this product as household waste. Hand it over to the appropriate collection point for the recycling of electrical and electronic equipment.

**Disposal of waste batteries.** This product contains batteries. Do not dispose of them with other household waste. Hand them over to the appropriate collection point for recycling.

Please note: proper product and battery disposal prevents potential negative consequences for human health and the environment. For detailed information, contact your local household waste disposal service or go to [www.milwaukeeinstruments.com](http://www.milwaukeeinstruments.com) (US only) or [www.milwaukeeinst.com](http://www.milwaukeeinst.com).

## RECOMMENDATION

Before using this product, make sure it is entirely suitable for your specific application and for the environment in which it is used. Any modification introduced by the user to the supplied equipment may compromise the meter's performance. For your and the meter's safety do not use or store the meter in hazardous environment. To avoid damage or burn, do not perform any measurement in microwave ovens.

## WARRANTY

These instruments are warranted against defects in materials and manufacturing for a period of 2 years from the date of purchase. Electrodes and Probes are warranted for 6 months. This warranty is limited to repair or free of charge replacement if the instrument cannot be repaired. Damage due to accidents, misuse, tampering or lack of prescribed maintenance is not covered by warranty. If service is required, contact your local Milwaukee Instruments Technical Service. If the repair is not covered by the warranty, you will be notified of the charges incurred. When shipping any meter, make sure it is properly packaged for complete protection.

*Milwaukee Instruments reserves the right to make improvements in design, construction and appearance of its products without advance notice.*

**THANK YOU FOR CHOOSING**



Sales and Technical Service Contacts:

Milwaukee Electronics Kft.  
Alsó-kikötő sor 11C  
H-6726 Szeged - HUNGARY  
tel: +36 62 428 050  
fax: +36 62 428 051  
[www.milwaukeeinst.com](http://www.milwaukeeinst.com)  
e-mail: [sales@milwaukeeinst.com](mailto:sales@milwaukeeinst.com)

Milwaukee Instruments, Inc.  
2950 Business Park Drive  
Rocky Mount, NC 27804 USA  
tel: +1 (252) 443-3630  
fax: +1 (252) 443-1937  
[www.milwaukeeinstruments.com](http://www.milwaukeeinstruments.com)  
e-mail: [sales@milwaukeeinstruments.com](mailto:sales@milwaukeeinstruments.com)